

# \_ Flat Collection



# Flat Collection

Design VillaTosca

## FOGLI DI LUCE

Sottile ed elegante come un foglio luminoso, Flat condensa in 8 mm lo spessore del corpo lampada. La luce emessa risulta diretta verso il basso e al contempo verso l'alto, grazie ai tagli nella parte superiore.

## LAYERS OF LIGHT

Slender and elegant as a layer of light, Flat condenses in 8 mm the surface of the body lamp. The light is directly emitted both downward and upward, thanks to the openings on both top and bottom.

## FEUILLES DE LUMIÈRE

Aussi fine et élégante qu'une feuille de lumière, Flat condense en 8 mm l'épaisseur du corps de la lampe. Grâce aux découpes situées sur la partie supérieure, la lumière émise est dirigée à la fois vers le bas et vers le haut.

## BLÄTTER AUS LICHT

Schmal und elegant wie ein Blatt aus Licht, kondensiert in 8 mm die Oberfläche der Körperlampe. Sie strahlt direktes Licht sowohl nach oben als auch nach unten dank den Schnitten auf der Oberfläche.

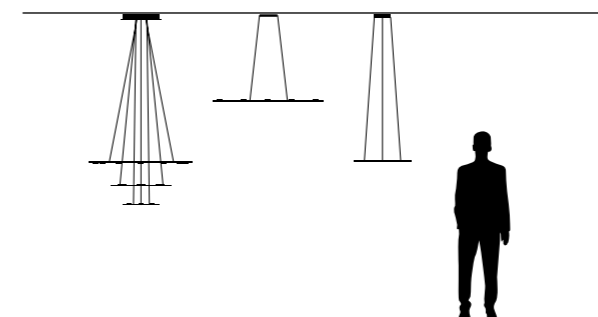

**FLAT 04 - 05 - 06**  
**Suspension lamp**

-  
Lampada a sospensione realizzata in alluminio a 4, 5 o 6 punti luce disposti linearmente. Sorgenti LED integrate a luce diretta ed indiretta grazie a diffusori lenticolari in policarbonato ed alimentatore elettronico dimmerabile TRIAC. Disponibile in alluminio anodizzato naturale, alluminio anodizzato nero ed oro champagne.

-  
Suspension light with 4, 5 or 6 light spots arranged in a line. Embedded LED lighting source with direct and indirect light enabled by polycarbonate lentiform diffusers and TRIAC dimmable electronic power supply. Available in natural anodized aluminium, black anodized aluminium or gold champagne.

-  
Suspension en aluminium avec 4, 5 ou 6 points lumineux disposés linéairement. Sources LED intégrées diffusant une lumière indirecte vers le haut et directe vers le bas grâce à des diffuseurs lenticulaires en polycarbonate. Driver dimmable TRIAC. Disponible en aluminium anodisé naturel, aluminium anodisé noir et or champagne.

-  
Hängelampe mit 4,5 oder 6 Lichtpunkten im Kreis. Integrierte LED-Lichtquelle mit direktem und indirektem Licht ermöglicht vom linsenförmige Polycarbonat-Diffusoren und TRIAC dimmbare, elektronische Stromversorgung. Verfügbar in natureloxiertem Aluminium, schwarzem oder goldchampagnerfarben eloxiertem Aluminium.



**FLAT 04**

**Suspension lamp**

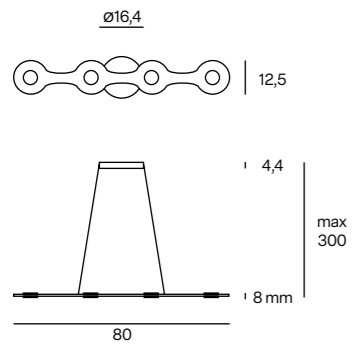

- 172 Natural Anodized aluminium
- 174 Black Anodized aluminium
- 177 Champagne Gold

LED 25,2W 2250lm 2700K CRI>90  
LED 25,2W 2500lm 3000K CRI>90  
Dimmable TRIAC

CE Classe I IP20

Unit: cm

**FLAT 05**

**Suspension lamp**

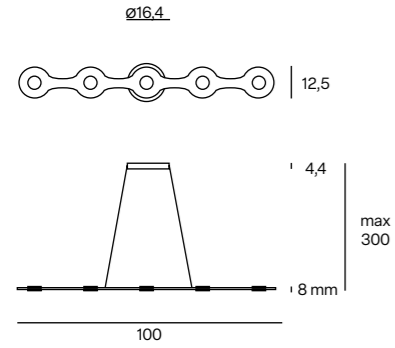

- 172 Natural Anodized aluminium
- 174 Black Anodized aluminium
- 177 Champagne Gold

LED 31,5W 2850lm 2700K CRI>90  
LED 31,5W 3150lm 3000K CRI>90  
Dimmable TRIAC

CE Classe I IP20

Unit: cm

**FLAT 06**

**Suspension lamp**

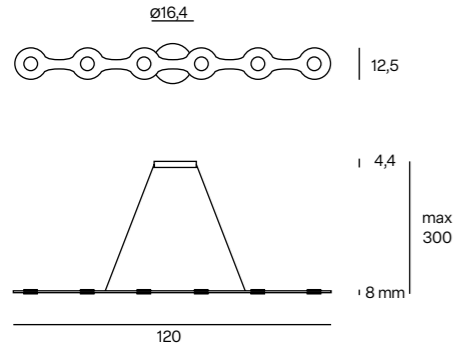

- 172 Natural Anodized aluminium
- 174 Black Anodized aluminium
- 177 Champagne Gold

LED 37,8W 3420lm 2700K CRI>90  
LED 37,8W 3800lm 3000K CRI>90  
Dimmable TRIAC

CE Classe I IP20

Unit: cm

**FLAT RING 3**

**Suspension lamp**

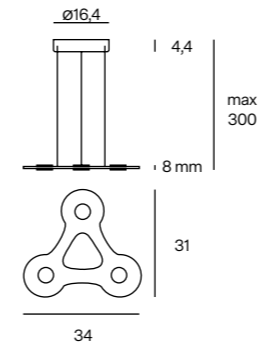

- 172 Natural Anodized aluminium
- 174 Black Anodized aluminium
- 177 Champagne Gold

LED 18,9W 1700lm 2700K CRI>90  
LED 18,9W 1890lm 3000K CRI>90  
Dimmable TRIAC

CE Classe I IP20

Unit: cm

**FLAT RING 6**

**Suspension lamp**

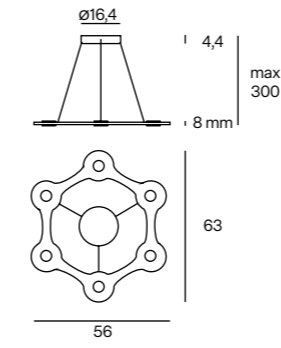

- 172 Natural Anodized aluminium
- 174 Black Anodized aluminium
- 177 Champagne Gold

LED 37,8W 3420lm 2700K CRI>90  
LED 37,8W 3800lm 3000K CRI>90  
Dimmable TRIAC

CE Classe I IP20

Unit: cm

**FLAT RING 12**

**Suspension lamp**

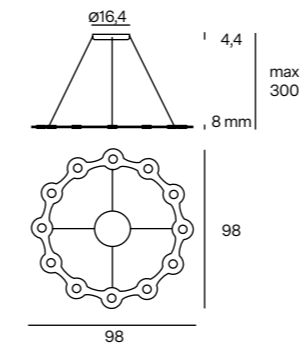

- 172 Natural Anodized aluminium
- 174 Black Anodized aluminium
- 177 Champagne Gold

LED 75,6W 6800lm 2700K CRI>90  
LED 75,6W 7560lm 3000K CRI>90  
Dimmable TRIAC

CE Classe I IP20

Unit: cm