



## LIGHT SOURCE

LUXSI FLOOR

LED 220/240V 35W  
3400lm 2700k CRI>97  
BEAM ANGLE: 45°

## CERTIFICATIONS

MADE IN ITALY	Certified production in Italy
	Class 2
	Fixture fitted for direct assembly on normally inflammable surfaces.
luum	Spot created with Luum Technology
RoHS	Restriction of Hazardous Substances Directive
IP20	Protected against the entry of solid objects larger than 12mm. No protection against the ingress of water.
CE	Product conforms to European Directive Community



### AVVERTENZA

La sicurezza dell'apparecchio é garantita all'osservanza di queste istruzioni pertanto si raccomanda di conservarle.  
Tutte le operazioni di montaggio, manutenzione e sostituzione lampadine, vanno eseguite assicurandosi che la rete di alimentazione sia disinserita.  
Non deve essere superata la potenza massima indicata.

### WARNING

The safety of the fitting is guaranteed by the correct use of the following instructions. It is therefore necessary to keep them.  
When carrying out all assembly, maintenance and lamp replacement operations, make sure that the power is off.  
Do not exceed the maximum power indicated.

### AVERTISSEMENT

La sureté de l'appareil est garantie avec l'utilisation appropriée des instructions suivantes. Il est donc nécessaire de les garder. Toutes les opérations de montage, entretien et remplacement de l'ampoule ne doivent étre effectuées qu'après avoir coupé le courant.  
Il ne faut pas dépasser la puissance maximum indiquée.

### SICHERHEITSHINWEISE

Die Sicherheit des Gerates ist nur garantiert wenn die folgenden Vorschriften eingehalten werden. Es ist daher notwendig diese aufzubewahren.  
Montage, Wartung und Lampenwechsel dürfen nur nach Unterbrechung des Netzanschlusses durchgeführt werden.  
Nie die höchste angegebene Leistung überschreiten.



### ATTENZIONE

L'installazione deve essere effettuata da installatori qualificati nel pieno rispetto della normativa.  
Se il cavo flessibile esterno di questo apparecchio viene danneggiato, deve essere sostituito esclusivamente dal costruttore, dal suo servizio di assistenza o da personale qualificato equivalente, al fine di evitare pericoli.

### ATTENTION

The fitting should be installed by qualified installers to comply with the HD 384 standards.  
If the external flexible cable of this device is damaged, it has to be replaced only by the manufacturer, by its service assistance or by similar qualified personnel in order to avoid risks.

### ATTENTION

L'installation doit étre effectuée par des installateurs agréés, conformément à la norme HD 384.  
Si le câble extérieur flexible de cet appareil est endommagé, il doit étre remplacé exclusivement par le constructeur, son service d'assistance ou par du personnel équivalent qualifié, afin d'éviter tout danger.

### ACHTUNG

Die Leuchte ist von qualifizierten Fachleuten im Einklang mit der Bestimmung HD 384 zu installieren.  
Wenn das externe flexible Kabel dieses Gerätes beschädigt ist, muss es nur durch den Hersteller, seinen Kundendienst oder einer ähnlich qualifizierten Person, um Gefahren zu vermeiden.



- Il simbolo riportato sull'apparecchio indica che il prodotto deve essere smaltito in modo differenziato dai rifiuti urbani.

- The sign shown on the device indicates that the product must be thrown out in a different manner than with the urban trashes.

- Le symbole montré sur l'appareil indique que le produit doit étre débarrassé de façon différente que les déchets urbains.

- Das auf dem Gerät wiedergegebene Symbol zeigt an, dass das Produkt getrennt vom Stadtüll entsorgt werden muss.

## LUMEN CENTER ITALIA Srl

Via Donatori del Sangue n.37  
20010 Santo Stefano Ticino (MI) - Italy  
tel. +39 02 3654 4311  
info@lumencenteritalia.com

www.lumencenteritalia.com

LUXSI FLOOR  
Design Ahlux, 2022

# Lumen center.

Istruzioni di montaggio  
Assembly instructions  
Instructions de montage  
Montage anleitungen

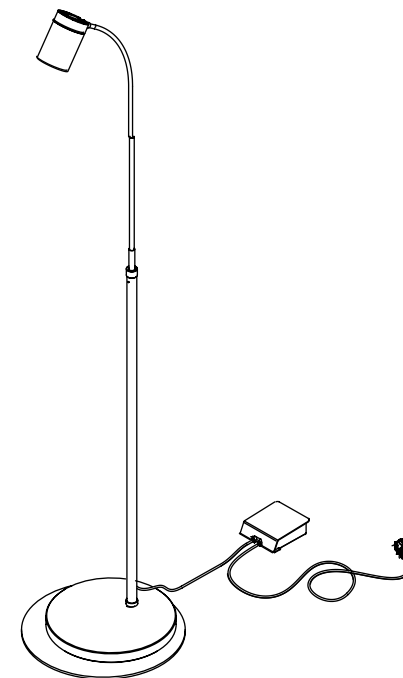

**01**

- Fissare la base all'asta con la vite.
- Secure the base to the rod with the screw.
- Fixez la base à la tige avec la vis.
- Befestigen Sie die Basis mit der Schraube an der Stange.

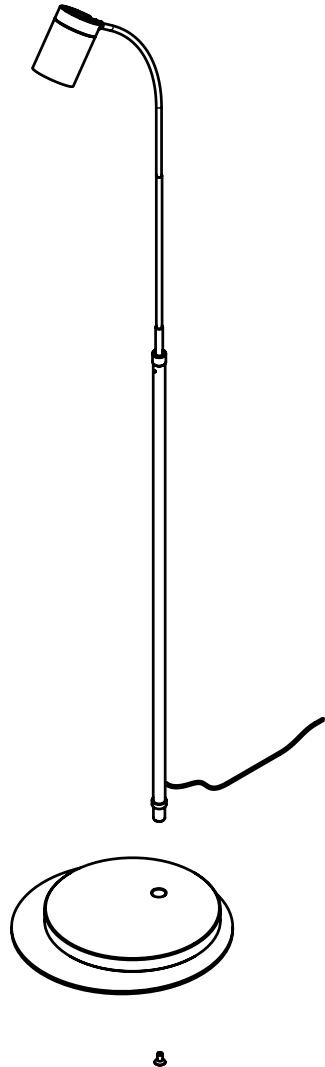

**02**

- Regolazione della intensità luminosa 10-100% con comando a pulsante:
- Light regulation 10-100% by push button:
- Réglage de la puissance lumineuse 10-100% avec bouton-poussoir:
- Lichtregulierung 10-100% durch den Taster:

**2a**

- Pressione breve per accendere e spegnere.
- Short push to turn on and off.
- Appui court pour allumer et éteindre.
- Kurzer Druck für Ein und Ausschalten.

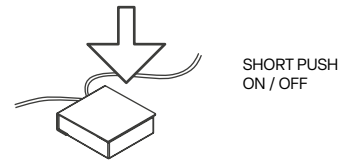

**2b**

- Pressione prolungata per aumentare o diminuire l'intensità luminosa.
- Longer push to increase or decrease light intensity.
- Appui long pour augmenter ou diminuer l'intensité de la lumière.
- Verlängerter Druck für Steigerung oder Minderung der Lichtintensität.

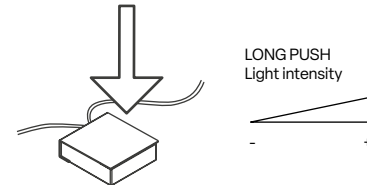

**2c**

- Per un nuovo comando di accensione, regolazione o spegnimento, rilasciare il pulsante e dare nuovamente il comando desiderato.
- For another on, regulation or off command, release the push button and give the desired command again.
- Pour une nouvelle gestion de l'allumage, réglage ou arrêt, relâchez le bouton et donner à nouveau la commande souhaitée.
- Zu erneuten Einschalten, Regulierung oder Ausschalten lassen Sie den Taster frei und erteilen Sie ihm nochmals den gewünschten Befehl.

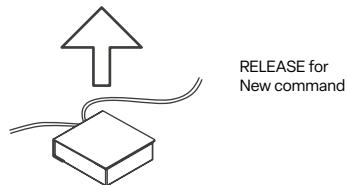

MOVIMENTI/ MOVEMENTS/ MOUVEMENTS/ BEWEGUNGEN

**03**

- Rotazione faretto 90° (linea tratteggiata). Rotazione dell'asta di 180°.
- Spotlight rotation 90° (dashed line). 180° rod rotation.
- Rotation du projecteur 90° (ligne pointillée). Rotation de la tige à 180°.
- Strahlerdrehung 90° (gestrichelte Linie). 180°-Stangendrehung.

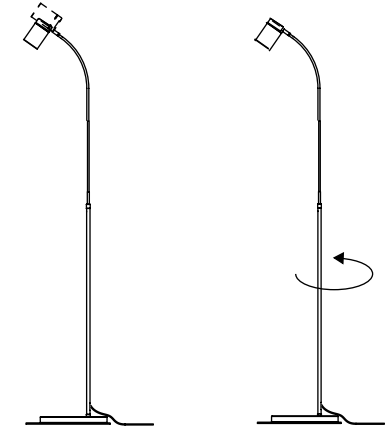

**04**

- Scorrimento asta max 800mm.
- Rod sliding max 800mm.
- Tige coulissante max 800mm.
- Stange verschiebbar max. 800 mm.

